

Differential pressure switches for air, flue and exhaust gases

Pressure switch for gas

DUNGS[®]
Combustion Controls

LGW...A4
LGW...A4/2

5.08



Technical description

The differential pressure switch LGW...A4 is an adjustable differential pressure switch as per EN 1854 for automatic burner controls.

It is suitable for switching a circuit on, off or over on changes in actual pressure value relative to the set reference value.

The reference value (switching point) is adjusted on a setting wheel provided with a scale. The test nipple is integrated in metal housing as standard.

Application

Differential pressure monitoring in firing, ventilation and air-conditioning systems. Differential pressure switches: suitable for air, flue and exhaust gases. Pressure switches: suitable for gases of families 1,2,3 and other neutral gaseous media.

Approvals

EU type testing certificate as per:

- EU-Gas Appliances Regulation
- EU-Pressure Equipment Directive

Pressure switch Class "S" as per EN 1854.

Approvals in other important gas-consuming countries.

Functional description

Differential pressure switch in pressure and vacuum ranges. The differential pressure acts via the diaphragm against the force of the setting spring on the microswitch. The pressure switch operates without any auxiliary power.

Differential pressure switch LGW...A4

The switching mechanism responds to differential pressure which acts between the two pressure chambers. It switches an electric circuit on, off or over when the set reference value is exceeded or undershot.

Overpressure switch LGW...A4

Pressure connection G 1/4

Single-acting pressure switch in the overpressure range.

The switching mechanism responds if there is an overpressure which switches on, off or over to an electric circuit if the set reference value is exceeded or undershot.

The pressure connection G 1/8 may not be closed.

Vacuum switch LGW...A4

Pressure connection G 1/8

Single-acting pressure switch in the low pressure range. The switching mechanism responds to vacuum which switches an electric circuit on, off or over when the set reference value is exceeded or undershot.

The pressure connection G 1/4 may not be closed.

LGW...A4 switching function

As pressure rises:

1 NC opens, 2 NO closes

As pressure falls:

1 NC closes, 2 NO opens

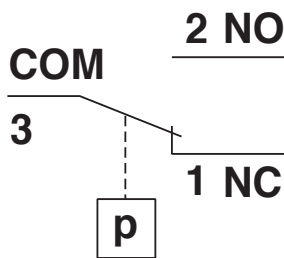

Definition of switching difference Δp

The switching difference Δp is the pressure difference between the upper and lower switching pressures.

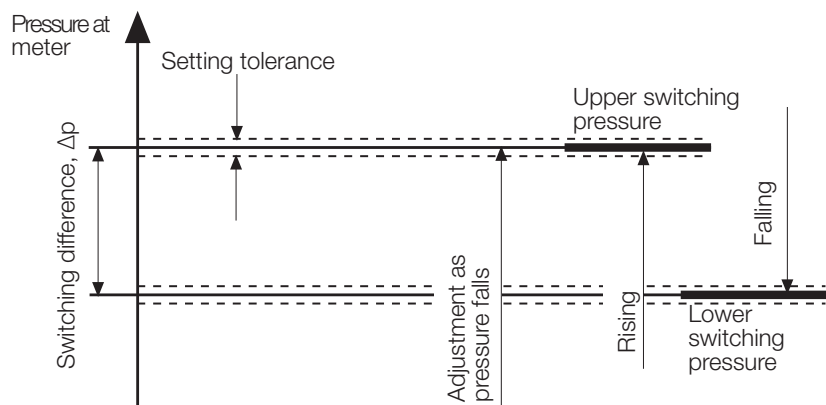

LGW...A4, Design: Clear cover

Protection class: IP 54

IP 54

5 Protection against ingress of solid particles $\varnothing \geq 1$ mm.
Protection against access to hazardous parts using $\varnothing \geq 1$ mm wire
Complete contact protection

4 Protection against a water jet.
No hazardous conditions may result.

LGW...A4/2, Design: Metal housing

Protection class: IP 65

IP 65

6 Protection against the entry of dust (dust sealed).
Protection against access to hazardous parts using $\varnothing \geq 1$ mm wire
Complete contact protection

5 Protection against a water jet from a nozzle directed at the unit (housing) from any directions
No hazardous conditions may result (water jet).

Specifications

Max. operating pressure	LGW 3 A4 - LGW 150 A4 LGW 3 A4/2 - LGW 150 A4/2	500 mbar (50 kPa) 500 mbar (50 kPa)
Pressure connection	P+: G 1/4 female thread ISO 228 on centre of housing underside: gas or air P+: G 1/4 screw plug on side of housing: gas or air P-: G 1/8 female thread ISO 228 on side of housing underside: only air	
Measuring connection	Instrument gland integrated in metal housing, \varnothing 9	
Temperature range	Ambient temperature: -15 °C to +70 °C Medium temperature: -15 °C to +70 °C Storage temperature: -30 °C to +80 °C	
Materials	<p>LGW...A4</p> <p>Housing base aluminum die casting Hood Polycarbonate Switch Polycarbonate Diaphragms NBR Switching contact Standard: Ag Optional: Ag gold-plated (Au), suitable for DDC applications: 24 VDC; 0.02 A</p> <p>LGW...A4/2</p> <p>Housing base Diecast aluminum Hood Extrusion cast zinc, powder-coated Switch Polycarbonate Diaphragms NBR Switching contact Standard: Ag Optional: Ag gold plated (Au), Suitable for DDC applications: 24 VDC; 0.02 A</p>	
Switching voltage	Ag contact Au contact	AC eff. min. 24 V max. 250 V DC min. 24 V max. 48 V DC min. 5 V max. 24 V
Nominal current	Ag contact Au contact	AC eff. 10 A DC 20 mA
Switching current	Ag contact Au contact	AC eff. min. 20 mA max. 6 A bei $\cos \varphi$ 1 AC eff. min. 20 mA max. 3 A bei $\cos \varphi$ 0,6 DC min. 20 mA max. 1 A DC min. 5 mA max. 20 mA
Electrical connection	Standard Special design	at screw terminals via M20 x 1.5 cable gland plug connection for line sockets as per DIN EN 175 301-803, 3-pin with protection contact
Degree of protection	LGW...A4 LGW...A4/2	IP 54 as per IEC 529 (EN 60529), (transparent hood) IP 65 as per IEC 529 (EN 60529), (metal housing)
Adjustment	If pressure increases in vertical installation position. Optionally adjustment for rising or falling pressure possible on site. If installation position deviates, note change in switch point.	
Setting tolerance	\pm 15% switch point deviation referred to reference value and installation in vertical position. Optionally, rising (\uparrow) or falling (\downarrow) adjustment possible on site.	
Deviation	Permissible deviation of the set value $\leq \pm 15\%$ in the service life test according to EN 1854	
Reference value setting device	Standard: blue Version "Y": Yellow	

Dimensions [mm]

LGW... A4

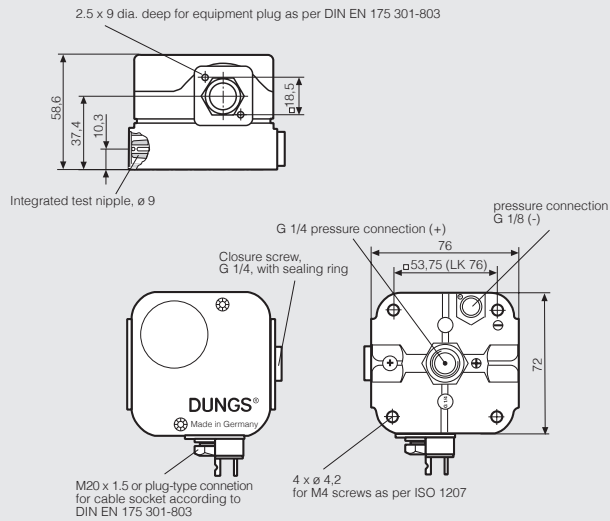

LGW... A4/2

with metal housing, plug-in connection for sockets accord. to DIN EN 175 301-803

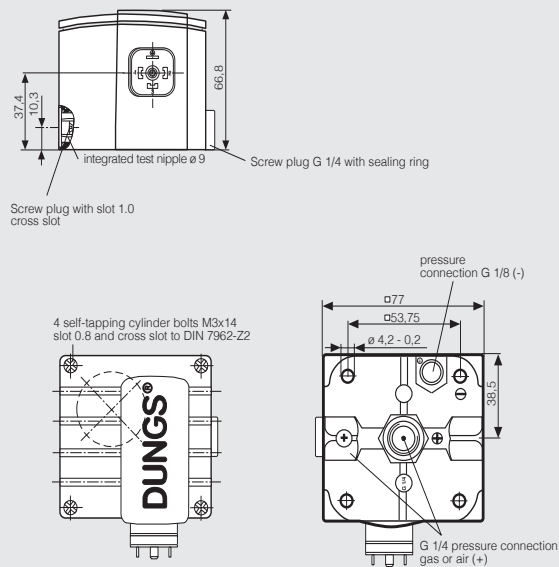

Installation position

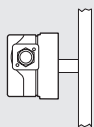

Standard installation position
In case of deviations, observe the changes in switching point

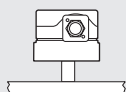

When installed horizontally, the pressure switch switches at a pressure higher by approx. 0.5 mbar

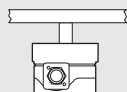

When installed horizontally overhead, the pressure switch switches at a pressure lower by approx. 0.5 mbar

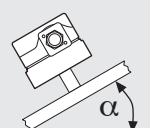

When installed in an intermediate installation position, the pressure switch switches at pressure deviating from the set reference value by max. ± 0.5 mbar.

Designation

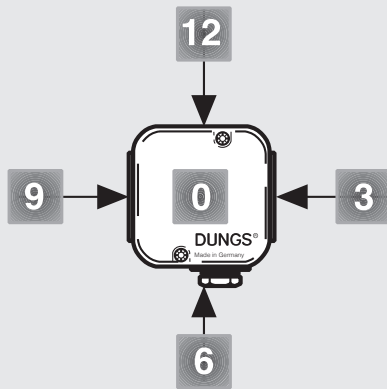

LGW 3 A4 [Y-Ag-M-MS9-V0-VS3]

→	Pressure connection	
	V0	Pressure connection G 1/4 position 0
	V3	Pressure connection G 1/4 position 3
→	screw plug	
	VS0	screw plug at position 0
	VS3	screw plug at position 3
→	Test nipple	
	MS3	Test nipple at position 3
	MS9	Test nipple at position 9
	M9	Test nipple, open position 9
→	Electrical connection	
	M	M20 x 1.5 cable gland
	G 3	Device connector
→	Contact material	
	Ag	
	Au	
→	Version	
	Y	Gas model (yellow reference value setting device)
→	Adjustment ranges [mbar]	
	0,4 - 3	
	1 - 10	
	2,5 - 50	
	30 - 150	
→	Pressure switch design	
	LGW...A4	Clear cover, PC, (IP 54) Differential pressure switch switches when the pressure exceeds or drops below the adjusted setpoint.
	LGW...A4/2	Metal housing, powder-coated, (IP 65)

Order example

Pressure switch design

LGW...A4 differential pressure switch

Setting range

30 - 150 mbar

Contact material

Ag

Electrical connection

Cable gland M20 x 1.5

Test nipple

MS 9

Pressure connection G 1/4

V0-VS3; at position 0 and position 3 with closure screw

LGW 150 A4 [Ag-M-MS9-V0-VS3]

Accessories for

LGW...A4 pressure switch

Order No.





Kit: G3 equipment plug, 3-pin + E	219 659
Line sockets, 3-pin + E grey GDMW	210 318
G 1/4 test nipple and seal ring (1 x)	266 042
G 1/8 test nipple and seal ring (1 x)	230 397
G 1/4 screw plug and seal ring (1 x)	266 044
G 1/8 screw plug and seal ring (1 x)	270 802
Double pressure switch mounting kit (not for /2-version)	213 910
Metal mounting bracket	230 288
G 1/4 screw-in glands, only for air	230 279
G 1/8 screw-in glands, only for air	230 278
Mounting kit glowlamp , 230 V yellow	231 773
Mounting kit glowlamp, 120 V yellow	231 772
Mounting kit display-LED, 24 V yellow	231 774
Mounting kit glowlamp, 230 V green	248 239
Mounting kit display-LED, 24 V green	248 240

Differential pressure switches
for air, flue and exhaust gases
Pressure switch for gas

LGW...A4
LGW...A4/2

DUNGS[®]
Combustion Controls

Technical Summary 1 mbar = 100 Pa = 0,1 kPa ≈ 10 mm WS 1 Pa = 0,01 mbar ≈ 0,1 mm WS

Type	Version	Order No.	Order No.	Setting range		Switching difference [mbar]		Degree of protection	
				[mbar]	max.	p ↑ min.	p ↑ max.		
	[Ag-M-MS9-V0-VS3]	1 piece	48 pieces						
LGW...A4 Differential pressure switch	LGW 3 A4	272 338	221 590	0,4 - 3	± 15 %		≤ 0,3	≤ 0,3	IP 54
	LGW 10 A4	272 344	221 591	1 - 10	± 15 %		≤ 0,5	≤ 0,5	IP 54
	LGW 50 A4	272 342	221 592	2,5 - 50	± 15 %		≤ 1	≤ 1,5	IP 54
	LGW 150 A4	272 353	221 593	30 - 150	± 15 %		≤ 3	≤ 5	IP 54
	[Au-M-MS9-V0-VS3]	1 piece	48 pieces						
LGW...A4 Differential pressure switch	LGW 3 A4	229 382	—	0,4 - 3	± 15 %		≤ 0,3	≤ 0,3	IP 54
	LGW 10 A4	229 383	—	1 - 10	± 15 %		≤ 0,5	≤ 0,5	IP 54
	LGW 50 A4	229 385	—	2,5 - 50	± 15 %		≤ 1	≤ 1,5	IP 54
	LGW 150 A4	229 386	—	30 - 150	± 15 %		≤ 3	≤ 5	IP 54
	[Ag-G3-MS9-V0-VS3]	1 piece	48 pieces						
LGW...A4 Differential pressure switch	LGW 3 A4	272 351	230 630	0,4 - 3	± 15 %		≤ 0,3	≤ 0,3	IP 54
	LGW 10 A4	272 348	—	1 - 10	± 15 %		≤ 0,5	≤ 0,5	IP 54
	LGW 50 A4	272 347	230 632	2,5 - 50	± 15 %		≤ 1	≤ 1,5	IP 54
	LGW 150 A4	272 361	—	30 - 150	± 15 %		≤ 3	≤ 5	IP 54
	[Y-Ag-M-MS9-V0-VS3]	1 piece	48 pieces						
LGW...A4 Differential pressure switch	LGW 3 A4 Y	272 358	242 864	0,4 - 3	± 15 %		≤ 0,3	≤ 0,3	IP 54
	LGW 10 A4 Y	272 360	242 865	1 - 10	± 15 %		≤ 0,5	≤ 0,5	IP 54
	LGW 50 A4 Y	272 355	242 866	2,5 - 50	± 15 %		≤ 1	≤ 1,5	IP 54
	LGW 150 A4 Y	272 359	242 867	30 - 150	± 15 %		≤ 3	≤ 5	IP 54
	[Ag-G3-MS9-V0-VS3]	1 piece	48 pieces						
LGW...A4/2 Differential pressure switch including line socket	LGW 3 A4/2	232 716	—	0,4 - 3	± 15 %		≤ 0,3	≤ 0,3	IP 65
	LGW 10 A4/2	232 717	—	1 - 10	± 15 %		≤ 0,5	≤ 0,5	IP 65
	LGW 50 A4/2	232 718	—	2,5 - 50	± 15 %		≤ 1	≤ 1,5	IP 65
	LGW 150 A4/2	232 719	—	30 - 150	± 15 %		≤ 3	≤ 5	IP 65

We reserve the right to make any changes in the interest of technical progress.

Head Offices and Factory
Karl Dungs GmbH & Co. KG
Karl-Dungs-Platz 1
D-73660 Urbach, Germany
Telefon +49 7181-804-0
Telefax +49 7181-804-166

Postal address
Karl Dungs GmbH & Co. KG
Postfach 12 29
D-73602 Schorndorf, Germany
e-mail info@dungs.com
Internet www.dungs.com